

FT16000 *Fast Tracker*

INSTRUCTION MANUAL



REG. TM

MINELAB ELECTRONICS PTY LTD

46 Beulah Road Norwood

South Australia 5067

Phone (08) 363 0899 Fax (08) 363 0973



AUTOMATIC GROUND TRACKING

The following simplified diagrams show how Automatic Ground Tracking (AGT) in the FT16000 allows you to cover more ground in less time.

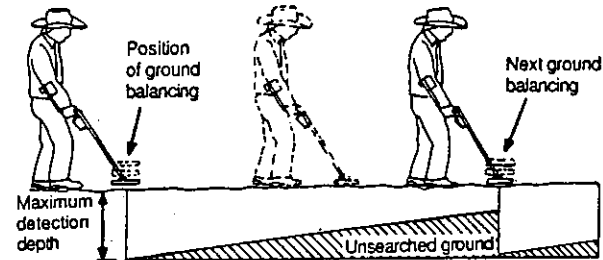

Figure 1 shows normal searching without AGT. Ground noises reduce the effective searching depth when you move from where you last ground balanced. The shaded area shows ground which is not properly searched.

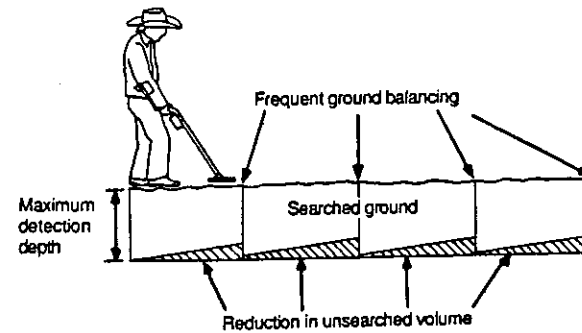

Figure 2 shows how a hardworking experienced professional will avoid missing treasure in that area. He rebalance's his detector more often: which is very time consuming.

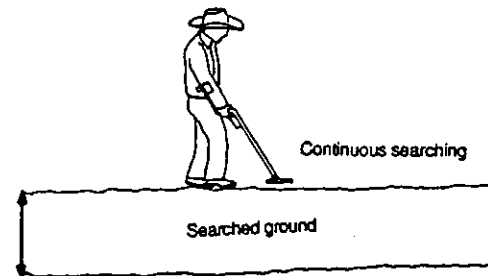

Figure 3 shows how genuine automatic ground tracking covers all the ground quickly and effectively. For this to occur, the detector must track quickly enough and not reduce in sensitivity.

TABLE OF CONTENTS

1.	GENERAL DESCRIPTION	1
2.	BASIC OPERATION	2
	2.1 Assembly Procedure	2
	2.2 Start-up Procedure in Basic Search Mode	4
	2.3 Headphone Socket	5
	2.4 Batteries	5
	2.5 Search Coil	7
3.	EXPLANATION OF CONTROLS	7
	3.1 VOLUME Knob and On/Off	7
	3.2 SOIL Switch	7
	3.3 SENSITIVITY Knob	8
	3.4 SOUND Switch	8
	3.5 THRESHOLD Knob	9
	3.6 DISCRIMINATE Knob	9
4.	GROUND NOISE REJECTION	11
	4.1 Automatic Ground Balancing (AGB)	11
	4.2 Automatic Ground Balance Tracking (AGB Tracking)	12
	4.3 Searching Modes	13
5.	DETECTION TIPS	14
	5.1 General Operation	14
	5.2 Pinpointing an Object	14
	5.3 Recommended Technique	15
	5.4 Ground Noises	16
	5.5 Clay Domes	17
	5.6 Searching for Gold	18
6.	PROPER CARE OF YOUR DETECTOR	19
7.	WARRANTY AND SERVICE	20
8.	SPECIFICATIONS	21

FT16000 Instruction Manual:

Version 1.0

November, 1992.

3. Slide the isolator rod (9) into the lower end (end without clip) of the lower shaft (8) until it clicks into place.
4. Remove the aluminium knurled nut (7) from the main shaft (2). Remove the friction ring (6) and tape from the Lower Shaft (8). Discard the tape. Slide the aluminium knurled nut (7) and then the friction ring (6) on to the lower shaft (8). Slide the lower shaft assembly into the main shaft (2) to a convenient length. Ensure the clip snaps into place. Firmly tighten, by hand the aluminium knurled nut on to the main shaft so that the friction washer clamps on to the lower shaft. This is to reduce any movement in this joint.

5. Slide the Arm-rest (1) (with support fins towards the rear) over the back of the Main Shaft (2) so that it "clicks" firmly at a convenient position. You can tighten or loosen it about the forearm by bending the fins.

6. Attach the Control Box (3) to the Main Shaft (2).

7. Wind the Cable (5) from the Search Coil (13) around the shaft fairly tightly (but without strain) and connect and screw the Cable plug (4) to the socket on the Control Box (3). Experienced operators recommend that you use heavy-duty insulating tape to secure the Cable to the Shaft to prevent unnecessary movement and snagging on objects.

8. Install the batteries (see Section 2.4) and you are ready to start searching.

9. You should use high quality headphones for serious searching. The loudspeaker is less sensitive and without headphones your ears are not protected from stray noises.

10. **Hipmounting or Strapmounting** is easily achieved by putting the control box into its protective Bag, which can be threaded onto your belt, or suspended from a strap. Unwind excess cable from the shaft and the Control Box. Fix the cable firmly to the shaft using tape.

Experienced users have found strapmounting most convenient if they spend a lot of time putting down and picking up the detector while working. After extensive use, the moving cable will deteriorate in its electronic properties and produce unwanted noise to the system.

2.2 Start-up Procedure in Basic Search Mode

This section describes how to check that the unit is operating correctly and how to set it up in the simplest searching mode.

1. Ensure that the detector is assembled correctly (see 2.1 above). Check all cables and connectors for serviceability. Adjust the Arm-rest, Control Box, Lower Shaft and Search Coil angle for comfortable and correct operation.

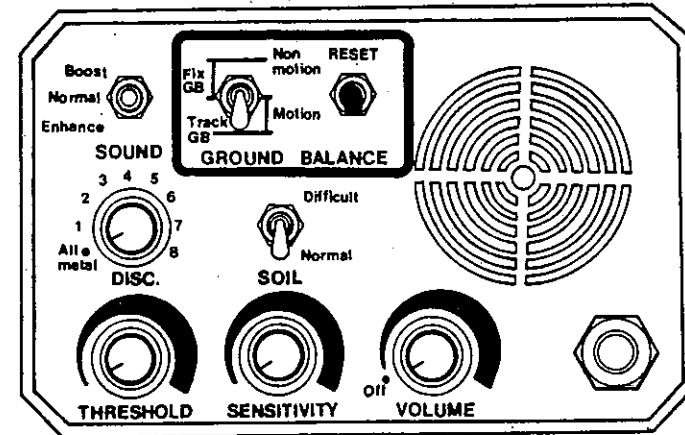

Figure 2. FT16000 Control Panel.

2. Set the Controls to the following recommended levels:

SOUND Switch:	"Normal"
GROUND BALANCE Switch:	"Track GB, Motion"
SOIL Switch:	"Normal"
DISCRIMINATE Knob:	"All Metal"
SENSITIVITY Knob:	To maximum

3. Hold the Search Coil waist high with the coil facing away from all clockwise direction and set it to its maximum. The detector will start full operation after a couple of seconds.
4. Adjust the Threshold Knob to a soft, comfortable audio level which will be pleasant to work with for a prolonged period. Readjust the Volume Knob to a level which is comfortable when sensing a "large" metal object. You may need to readjust the threshold.

5. To rapidly Ground Balance, hold the RESET switch in the "Up" position while continually raising and lowering the coil between 3 and 10 cm above the ground (Fig.4), or higher on exceptionally hot ground. Initially, you will hear a signal each time the coil moves in a particular direction. After a few moments, the sound will diminish with each movement until it almost vanishes. **You have just Automatically Ground Balanced** the detector to reject ground noises at that spot. Release the RESET switch. If step 5 is not carried out, the FT16000 will still automatically ground balance with use, after a few seconds.
6. You are ready to start detecting. The detector will **Automatically Track with the correct Ground Balance without any loss of sensitivity** as the ground changes.

2.3 Headphone Socket

The Headphone Socket is located at the bottom right corner of the front panel (see Figure 2). Headphones used should be of low impedance (but no less than 8 ohms). The socket will accept most mono and stereo headphones with a 1/4" jack. When the headphone jack is inserted, the loudspeaker is disconnected. When using headphones, you can tune the Threshold to a lower audio level and outside noises, such as wind, will be less distracting. Using headphones also conserves battery life. If the headphones have a "Stereo/Mono" switch, set it to "Stereo".

2.4 Batteries

The detector uses eight (8) 1.5 volt AA size (penlight) batteries. We recommend that you use the alkaline type because they are sealed and are less likely to leak. Remove the batteries if you will not be using the detector for a prolonged period. Store batteries in a cool, dry place and dispose of them thoughtfully (do not incinerate).

The FT16000 has an automatic "battery low" warning system. When the battery life is critically low, a distinct sharp "pip" will sound at about 20 second intervals through the headphones. These signals are quite distinctive and indicate that the batteries have about 15-20 minutes useful life left from when the sound first started.

Alkaline batteries should last approximately 25-30 hours.
Carbon batteries may last up to 20 hours.

Rechargeable Nicad cells will give over 6 hours continuous use when new, which will drop by about 45 minutes after about 300 cycles.

Using headphones will increase the life of batteries.
Always check the "use by dates" when buying new batteries.

The Battery Replacement Procedure is as follows:

1. Turn the detector off.
2. The battery compartment is located at the bottom of the Control Box. To remove the battery lid, press down on the end of lid nearest the front panel and slide it out.
3. Take out the two battery packs, taking care not to damage the connecting wires.
4. Remove the batteries from the packs and replace them with new ones. Be certain to replace them in their correct positions. Diagrams displaying polarity are on the packs. **Incorrect polarity will damage the detector.**
5. Carefully replace the loaded battery packs and slide the lid shut until it "clicks" firmly into place.

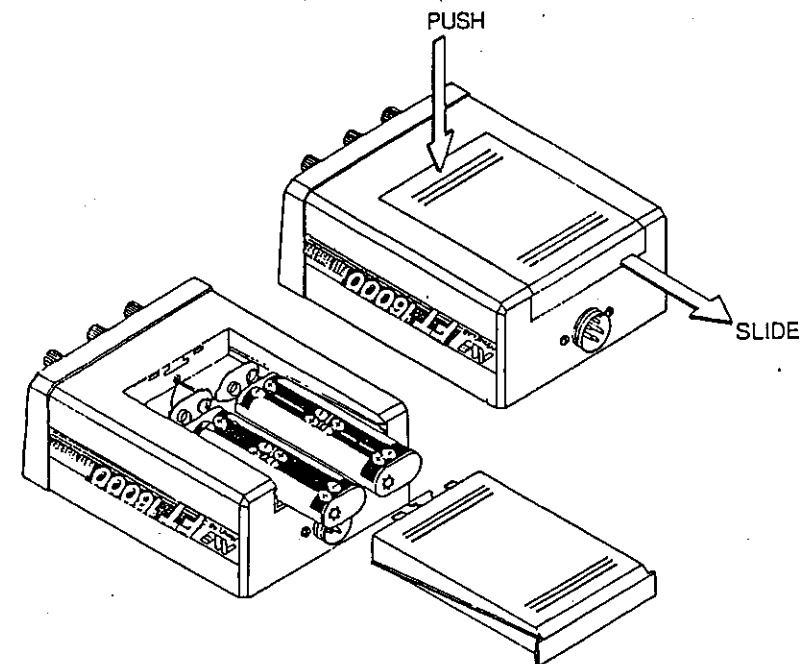

Figure 3. Battery removal and installation.

2.5 Search Coil

The FT16000 will only operate with the "SUPERSEARCH" range of coils manufactured by Minelab Electronics. The standard eight inch coil supplied with the unit is suitable for most searching. There are two optional coils available for the FT16000, a six inch and twelve inch elliptical coil. All "SUPERSEARCH" coils are of the "double D" configuration. Its advantages are greater depth, a wider search width, excellent performance in difficult soils and ease of pin-pointing.

Use a replaceable search coil cover to protect the Search Coil housing from abrasion and wear.

3. EXPLANATION OF CONTROLS

3.1 VOLUME Knob and On/Off

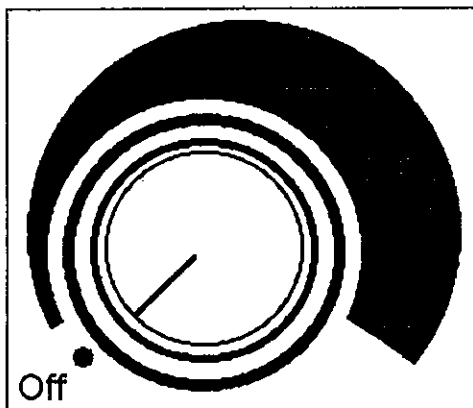

VOLUME

The detector is "off" when the knob is turned completely anti-clockwise. On turning the knob, you should feel a slight resistance and hear a click: this signifies that the machine is in the "on" position. When used in the field with high quality headphones, the operator will achieve the best results with the knob set between half and the maximum setting.

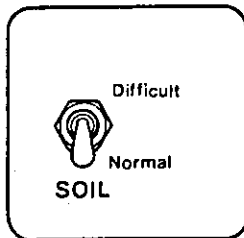

3.2 SOIL Switch

This toggle switch should always be set on the "Normal" position for good or clear ground. The "Difficult" setting slightly reduces sensitivity and should be selected only for ground highly concentrated in ironstone or mineralisation. If the ground still produces large variable responses, then you should decrease the

sensitivity by turning the sensitivity knob anti-clockwise. By doing so, some "depth" will be lost.

The detector will give a high pitch "squeal" if it overloads. This will occur when you sweep the Sensing Head close to a large object or if the head is brought too close to very "hot" ground. If you cannot bring the head close to the "hot" ground, set the Soil Switch to "Difficult".

3.3 SENSITIVITY Knob

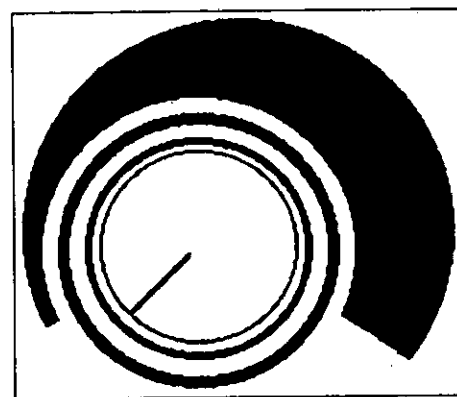

SENSITIVITY

To obtain maximum sensitivity, turn the knob to its extreme clockwise setting.

We recommend that in most ground you use it at maximum setting. This setting need only be altered in poor ground conditions such as heavy mineralisation or heavy ironstone. (The Soil Switch should be used in its Difficult Setting, prior to reducing sensitivity).

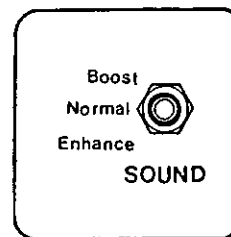

3.4 SOUND Switch

There are three alternative audio output sounds. These are "Normal", "Boost" and "Enhanced". In the "Normal" sound position, a detected signal increases the loudness of the response as is common in most detectors.

In "Boost" setting, the output signal is further amplified, offering extreme depth penetration in quiet soils or in a localized area. You are likely to encounter excessive "spurious" noise if you search in variable ground using this setting. Use this mode to pin-point an object which gives a faint signal under normal circumstances.

The "Enhanced" mode is specially designed to enable the detection of small and medium size nuggets in highly variable ground. In this mode, a detected signal also alters the frequency of the response. The ear is more sensitive to such changes and thereby you can detect small responses more accurately. Excessive numbers of "hot rocks" may make this mode ineffective in some grounds.

3.5 THRESHOLD Knob

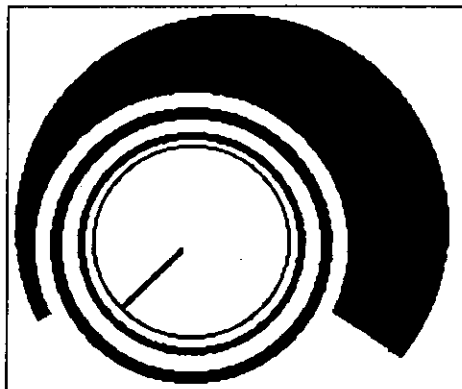

THRESHOLD

This control should be set just a slight turn of the knob past the point where the tone is just audible, but not at a level where prolonged use would be irritating. If you are in Fix GB, Non-motion mode, you will need to press the RESET Switch before you set the threshold (see 4.3 below)

3.6 DISCRIMINATE Knob

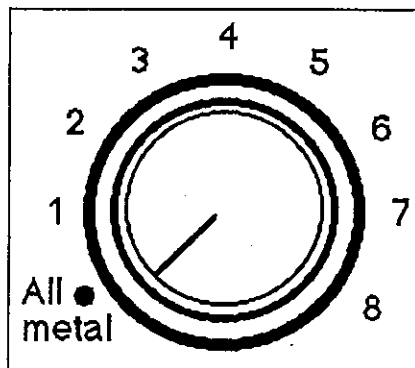

DISC

The discriminator is a useful aid to gold prospecting when its limitations are fully appreciated and the operator understands the conditions under which it will be reliable. It requires a proper understanding of the following paragraphs as well as skill gained from practice and experience. Many experienced users recommend that you dig all objects detected.

Use of the FT16000 discriminating mode will not sacrifice sensitivity or depth, but it will not necessarily discriminate at the full depth at which the object can be detected.

The discriminator is "off" or in "All metal" mode when the knob is turned completely anti-clockwise until it clicks "off". The discriminator does not function in the "Fix GB, Non-motion" mode.

A slight clockwise turn to setting "1" will switch the discriminator "on" to Ferrous/Non-ferrous discrimination mode. Ferrous objects will be signalled by stacatto-like sounds which are noticeably different from the non-ferrous sound.

As the knob is turned further clockwise, a greater variety of materials and objects will be signalled as non-targets by the stacatto-like sound. Experiment to determine the setting which best suits your purpose. Increasing the speed at which the Search Coil passes the object will improve the discrimination depth for a given object.

A unique feature of the discriminator is its ability to read the degree of ground interference to the process of discrimination. The detector automatically adjusts its discriminating power depending on the type of ground present, thereby achieving the maximum reliable discrimination depth. Thus in "mild" ground the detector will discriminate accurately at greater depth while in "hot" ground the discrimination depth is reduced to maintain reliable discrimination. At all times, however, an audible "object" sound is heard without loss of sensitivity so that no object can be missed. If the detector head is held in the air or stationary over the ground for an extended period of time the discrimination sensitivity increases to maximum. If it is then used on "hot" ground false discriminatory signals will first appear. After a short time, however, the detector will adjust to its new condition and the discriminatory power will be correctly adjusted.

The best procedure for attempting to discriminate in "hot" ground is to move the head over ground near the object (but not close enough to produce the object sound) to allow it to "read" the ground conditions and then pass it over the object. Repeated movement over a ferrous object will again desensitize the discriminator and false readings will begin to occur.

The discriminator must not be used to test the object beneath a hole that has been dug in the process of retrieving the object. Moving the detector head within the hole will often produce a false signal. Similarly the discriminator should not be used to test an object within the pile of soil which has been taken from this hole as again false signals are likely to occur, particularly in highly mineralised ground. The discriminator will give the most reliable result when the object is tested while it is on or within undisturbed ground. In all other cases it is likely to be unreliable.

When the Sensing Head is passed over large objects near the surface, the discriminator electronics may sometimes overload. This is indicated by a high pitch "chirp". Either sweep the Sensing Head further from the object or set the Soil Switch to "Difficult". The discriminator may sound where a "target" and a "non-target" object are close together. Consequently, most experienced users recommend that you retrieve all detected objects. (Under these circumstances, some discriminators give no sound at all and valuable objects may be lost.)

4. GROUND NOISE REJECTION The FT16000 excels in its ability to reject ground noises. Study this section to make certain that you correctly use its **ground balance tracking** ability. Remember that if the detector is not ground balanced correctly, it will miss potentially valuable targets.

4.1 Automatic Ground Balancing (AGB)

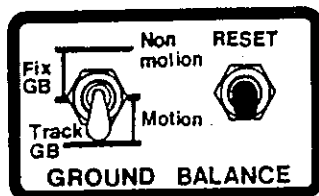

The **Ground Balance Switch** is a three position switch used to select the mode of operation when searching. The **RESET Switch** is used, if necessary, to force the detector to rapidly balance out the ground at a given spot in either of the two "Motion" modes of operation.

Select a patch of ground where you wish to cancel out the ground noises by ground balancing the detector. Set the detector to the "GB Track" mode of operation. In the first instance, hold the **RESET Switch** in the "Up" position while continually raising and lowering the Search Coil between 10 and 3 cm (4 and 1 inches) above the patch of ground. Initially, you will hear a signal each time the coil moves in one of the two directions. After a few moments, the sound will diminish with each movement until it almost vanishes. You are listening to the detector **automatically ground balancing**. When the sound diminishes no further, the detector is ground balanced on the chosen patch. Release the **RESET Switch**.

If the machine is a long way out of ground balance and the soil is exceptionally hot and you have difficulty bringing the machine into balance, back off by raising the head about 20cm and oscillating it more slowly. After balancing, the detector will operate normally.

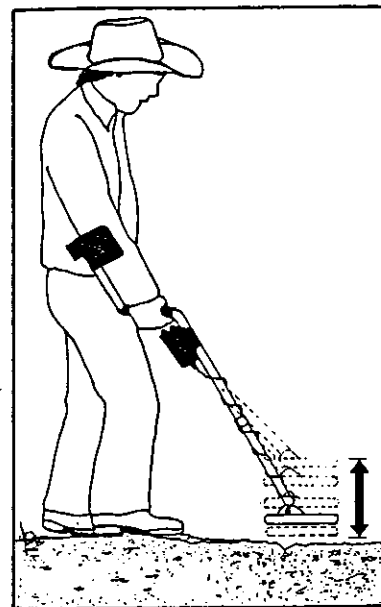

Figure 4. Automatic Ground Balancing (AGB) procedure

The **RESET Switch** forces the detector to ground balance at a particular spot. You can usually ground balance the detector rapidly on a new patch of ground without pressing the **RESET Switch** if you are in the "Track GB, Motion" mode of operation. Study section 4.2 carefully before you do so.

You should use this method of Automatic Ground Balancing in either of the two "Motion" searching modes when you wish to ground balance on a particular patch of ground. If you are in the "Fix GB, Motion" mode, you will need to repeat the AGB procedure quite often in variable ground. We recommend the "Track GB, Motion" mode for most searching for this reason.

4.2 Automatic Ground Balance Tracking (AGB Tracking)

This searching mode is selected by setting the **GROUND BALANCE Switch** to "Track GB, Motion". The "Motion" aspect of this mode indicates that you will hear a signal only when the Search Coil moves relative to the object being detected.

Before searching in this mode, you must be familiar with the Automatic Ground Balancing procedure described in section 4.1 above. It explains how to force the detector to balance on a chosen patch of ground.

In the "Track GB, Motion" mode, the detector continually adjusts its ground balance as the ground characteristics change and it thereby minimizes spurious ground noises. **The effective detection depth remains the same all the time**, so you can search a volume of ground more accurately and rapidly than if you had to manually adjust (or automatically adjust) the ground balance every time you judged that it needed readjustment.

Besides covering a greater amount of ground, and making operation easier, the "Track GB, Motion" mode has an additional unique advantage. Its ground balance setting is really *an average ground balance setting for the patch of ground most recently covered*, not just for the single patch on which one conventionally balances. Experience has shown that in most ground conditions,

this significantly smooths out ground noises, while targets still give a sharper distinctive signal.

You can use the "Track GB, Motion" mode effectively without the RESET Switch. However if the Ground Balance Tracking appears slow at some point where ground conditions change suddenly, use the RESET Switch to speed it up. The detector, on recognizing an object sound, may inhibit the AGB tracking. After a short time the AGB tracking is again enabled so that continued sweeping over the object may slightly reduce the object sound as the detector tries to balance onto the object.

We recommend that for maximum effectiveness in highly variable ground, you use the "Track GB, Motion" mode with the SOUND Switch set to "Enhance".

4.3 Searching Modes

The **Ground Balance Switch** selects the mode of operation when searching. These are "Track GB, Motion" (motion detector with automatic ground balancing and tracking); "Fix GB, Motion" (motion detector with ground balance fixed and the ability to use the AGB procedure using the RESET switch) and "Fix GB, Non-motion" (static detector with ground balance fixed at the setting when this mode was last switched on).

The "Track GB, Motion" mode has been described in section 4.2 above and is the recommended mode for most ground conditions. If the ground contains many ferrous objects, the ground balance will be continually adjusted and you may find it preferable to use the "Fix GB, Motion" mode.

The "Fix GB, Motion" mode allows you to fix the ground balance at a particular patch of ground (using the Automatic Ground Balancing procedure described in section 4.1) and keep it fixed at that setting. This is the conventional "motion" or "auto" mode used in most detectors with manual ground balancing controls. You can re-balance the detector at any other spot by pressing the RESET Switch and carrying out procedure 4.1.

In the "Fix GB, Non-motion" mode, the signal from a target will be maintained whilst holding the Search Coil stationary above the target. The ground balance setting will remain fixed at the setting when you switched on this mode. This mode can be used for pin-pointing and is sometimes used for searching small areas in hot ironstone conditions. In this mode, the discriminator is disabled and it is not possible to ground balance using the RESET switch only. You can, however, re-balance the detector at any spot by switching to the "Fix GB, Motion" mode, pressing the RESET Switch and carrying out procedure 4.1. If the audio background level fades away or gets too loud, press the RESET switch.

5. DETECTION TIPS

5.1 General

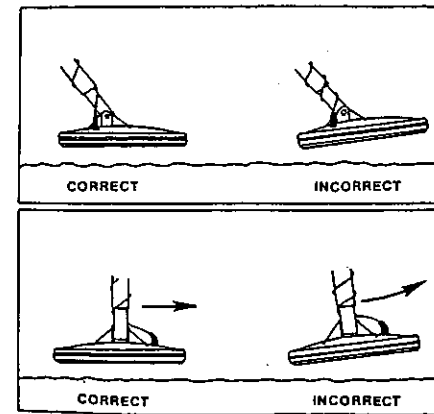

Figure 5. Maintaining Search Coil parallel to ground.

It is good practice to familiarize yourself with any new brand of detector. The best way to do this is to dig all object noises (including those giving ferrous signals even when searching for gold) as it will provide the operator with good experience in learning different audio signals and improving operator knowledge of ground noises.

5.2 Pinpointing an Object

The Search Coil should pass over the ground in a smooth and even motion. It is good practice to detect an object noise from several directions, listening to the audio signals and taking note where they are the strongest.

The "double-D" coils can be used to pin-point a small object to within two or three millimetres using the following procedure. Switch the detector to "Fix GB, Non-motion" mode and reset the detector with the Sensing Head placed near the object. Pass the head slowly over the object and hold it at the maximum sound position. For loud sounds greater precision can be achieved by flicking the RESET switch as the detector approaches the object. When the maximum sound position is located, draw a line on the ground which passes through the centre of the head in line with the direction of the shaft. Now move around at right angles to your previous position and repeat the above procedure to obtain a second ground line. The position of the intersection of these lines gives an accurate pin-pointing of the target.

The FT16000 will perform best when it is ground balanced to approximately 2 cm (1 inch) above the ground and kept at that search height. If you are not yet an experienced operator, you should practise maintaining constant coil height at the extremity of each swing. (Variation in coil height at the end of each swing can cause confusing sounds and will cause loss of depth.)

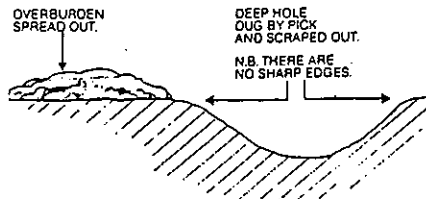

After making an appraisal of the target's position, best results will be gained by removing the top 3 or 4 centimetres of soil for approximately 14 cm radius of the target point and by spreading out the removed soil to one side of the cleared area. By passing the coil over the flattened soil, your detector will

signal if the object is small and contained in the top layer. It can be found more readily by this method than by digging a large hole. If it is not in the flattened soil, continue to dig and follow the same procedure. Do not leave sharp edges around the hole perimeter, because the detector could give a false reading on the edges of the hole.

It is better to go slowly because otherwise the object may be lost by spreading it too far away from the area being worked, or if it is a small find, you may end up burying it even deeper than it was when first detected.

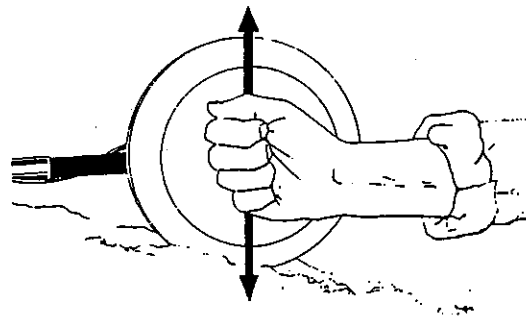

When the object has been removed from the hole, lay the detector down with the coil on its side, close by the hole. Gather a handful of soil at a time and pass it across the coil. The handful containing the object will emit a clear signal. Then halve that material into two hands and pass one at a time across the coil to further eliminate waste soil.

The procedure is continued until the object can be seen in the hand. Note that this procedure will probably put the detector off ground balance if you are in the "Track GB, Motion" mode.

Detect again over the hole to make sure that there are no other objects to be found (it wouldn't be the first time that gold nuggets have been found one under the other). Remember, fill in all holes you have dug: they are dangerous, unsightly and environmentally unacceptable.

5.3 Recommended Technique

It is important to scan an area with a broad even sweep of the detector head, keeping it at a constant height above the ground (approximately 2-3 cm depending on the ground conditions and obstacles such as rocks and pieces of wood and leaves).

Each sweep of the head should slightly overlap the previous sweep. However, unlike most other search coils, the FT16000 head is sensitive across its full width and therefore only a slight overlap is required.

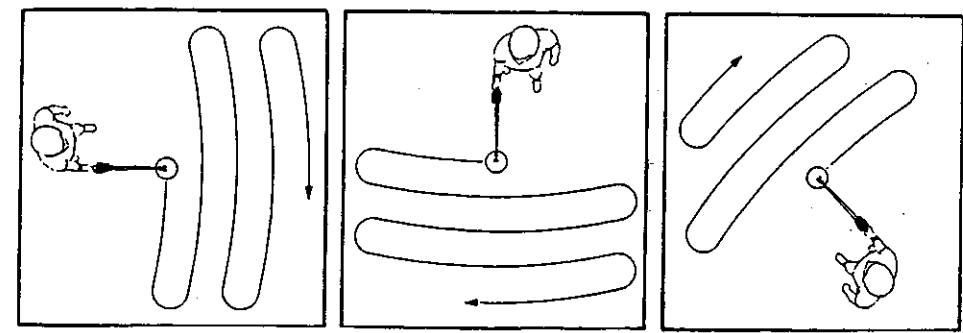

Figure 8. Recommended searching technique.

If a nugget of gold has been found there are likely to be others and a thorough search of the area from three different directions is recommended, as indicated in the three accompanying figures. This is because ground noises can vary depending on the direction the head passes across the ground. In one direction ground noises may mask out the sound of a nugget, whereas in another direction the sound may be readily discernible.

5.4 Ground Noises

There is nothing more annoying than getting a signal and digging but finding nothing. This can confuse the inexperienced operator and even destroy his confidence. It will take time and practice until you can learn to recognize which signal to pay attention to or to ignore.

Typically mineralised ground can make a detector respond with an indication that there might be an object reasonably deep beneath the surface. The sound could be rather broad and not very loud, or sometimes crisp and reasonably sharp.

Charcoal can sound loud at times and rather like a metallic object when close to the surface. Again, experience will teach the operator how to read the ground efficiently and gain understanding of the detector's response to the ground. Charcoal is usually created by farmers burning off tree stumps or by bushfires. The growth is burnt below the ground level, so it is not always obvious what the sounds are until you have actually dug up the causes of these noises a few times.

Other noises which most affect detectors are "hot" rocks. These are rocks rich in iron which have very strong audio signals. Some are strong and others are weak. With the strong ones, some detectors have problems in tuning them out, but with the FT16000 signals from hot rocks are not as great a problem. If you are still not sure, switch the SOIL Switch to "Difficult" and reduce the sensitivity by turning the SENSITIVITY Knob anti-clockwise. If the signal continues, there is a good chance that there could be at least some gold in that hot rock. Breaking the rock in two, then passing both sections of the rock across the coil, one after the other, will determine which piece contains the gold.

Sometimes "negative" hot rocks or ground "holes" are encountered. In this case the sound from the detector is reduced as it passes over the rock or "hole". Nevertheless the detector, on recovering from this loss of sound, can give an audible signal which to the beginner may be confused with the sound of an object. Experience will soon enable the operator to recognize this characteristic sound which is in fact quite different from an object. There is a simple procedure to check if such a hot rock or "hole" is present. Simply switch to "Fix GB, Non-motion" mode and move the detector head slowly over the section of ground where the effect is heard. The drop in sound intensity is a clear indication that no object is present.

If you find a broad "positive" sound which you feel is probably due to mineralisation but is positive enough to make you suspect a possible deep object, pass the search coil in a circular path around the centre of the positive sound source, while maintaining the closest edge of the search coil about 2 to 3 inches from this centre. After 2 or 3 rotations (1 to 1.5 seconds each.) pass the coil directly over the centre and listen to the "positiveness" of the signal. Repeat this procedure but this time with the search coil at right angles to the previous orientation and pass the coil over the positive sound centre at right angles to the first pass. If both passes result in a significant positive response, dig!

5.5 Clay Domes

A common occurrence in nugget bearing country is soil mineralisation which is commonly known as "clay domes". These are regions of rather broad sound which could be confused with the sound which would come from a deep large nugget.

The following procedure will quickly establish whether or not the sound comes from clay or a metal object. Remove about 4 cm (1.5") of soil in a broad 30 cm diameter circle with no sharp edges. This will allow the Search Coil to approach the "object" by about 4 cm. Now with the coil in this lowered position over the hole attempt to ground balance the signal. If ground balance can be achieved then this source of sound is probably clay, since it is not possible to ground balance a metal object which has been brought closer to the coil. In addition, the signal from a metal object is greatly enhanced when the

object is brought even slightly closer to the head, whereas the clay, because it is not concentrated, does not produce a greatly enhanced signal even when the head can be lowered. Be careful that the edges of the shallow hole are not producing spurious signals. The technique requires practice and experience but it is essential to develop a good technique to avoid digging many deep holes unnecessarily.

5.6 Searching for Gold

To have a good chance of detecting gold, it is necessary to search out areas where "coarse gold" is known to have been found, or other areas where it is likely to occur. The term "coarse gold" refers to gold ranging in size from a grain of wheat to many grams and in some cases hundreds of grams.

Many nugget-bearing areas are the result of broken down gold reefs containing quartz and ironstone. Experienced prospectors learn to "read the ground" and look for tell-tale signs indicating potential gold bearing fields. It is a fascinating and exciting hobby to learn some of these skills and apply them in your search for gold.

The modern metal detector has given today's prospector enormous advantages over the prospectors of old. The ground can be rapidly scanned until a small piece of gold is found and then a study of the area made to decide where other gold nuggets are likely to be located. It is then best to make a systematic search of the area as indicated in 5.3 above.

The main problem encountered while using metal detectors is the presence of heavy concentrations of ironstone. This is particularly the case in some of the richest known fields in Australia or the "black sands" areas of North America. It appears that gold nuggets and ironstone often go together, and in fact many gold nuggets have ironstone embedded in them or are encased in ironstone and others show strong ironstone staining. Some of these fields have only been superficially worked because of the interference to the detector caused by the ironstone. Usually only the most persistent professional is prepared to spend the time and energy necessary to cope with these conditions, and then only partially.

6. PROPER CARE OF YOUR DETECTOR

The FT16000 is a high-quality electronic instrument, finely engineered and packaged in a durable and rugged housing. Taking proper care is mostly common sense.

1. Do not leave batteries in the Control Box when the detector is not in use for a period exceeding two weeks. Damage caused by leaking batteries can be severe and would void the warranty through user negligence.
2. If temperatures are very high, do not leave the detector in the sun longer than necessary. Covering it from direct sunlight will help protect it. Try to avoid leaving it in a closed trunk of the car sitting in the sunlight.
3. The Search Coil housing will wear through if you scrub the ground with it while searching. We recommend that you use an easily replaceable skid plate to protect it, and replace it before it wears out.
4. The Bag is designed to protect the Control Box, especially from dust, mist and rain. It will also cushion potentially damaging knocks. Use the Bag where possible.
5. Whilst the Control Box has been designed to be water resistant, it is not waterproof. Avoid wetting it unnecessarily. Never allow the box to come into contact with petrol or other oil based liquids.
6. Should the Search Coil be used in salt water, it must be washed with fresh water.
7. Keep the unit dry and clean and avoid getting sand and grit into the shafts or the tightening nuts. Do not use solvents to clean the detector. Use a damp cloth with mild soap detergent.

7. WARRANTY AND SERVICE

There is a two-year parts and labour warranty on the FT16000. Refer to your Warranty Card for details. The Search Coil is warranted for one year. Refer to supplier or Minelab for service, either in- or out-of-warranty.

NOTE. This warranty is not transferable, nor is it valid unless the enclosed warranty registration card is returned to Minelab Electronics Pty. Ltd. or an authorised Minelab Electronics Pty. Ltd. regional distributor within 14 days of the original purchase, for the purpose of recording this date, which is the actual commencement of the warranty.

The Minelab warranty does not cover damage caused by accident, misuse, neglect, alteration, modifications or unauthorised service.

For specific details of the Minelab warranty please refer to the machine's 'Product Warranty Card'.

8. SPECIFICATIONS (FT16000)

These are subject to modification without notice.

Length	Extended	1350mm (53")	
	Un-assembled	840mm (33")	
Weight	Complete (excluding battery)	1620g	
	Control Box (" ")	620g	
	Shaft and Search Coil	925g	
Frequency	VLF search	7.825 kHz	
Ground Rejection	Automatic with no loss of sensitivity in all modes		
Search Modes	Tracking Ground Balance, Motion with Threshold		
	Fixed Ground Balance while searching, Motion with Threshold		
Controls	Fixed Ground Balance, Non-motion with Threshold		
	Discrimination All metal / Variable: adjustable control, no loss of sensitivity while eliminating discriminating.		
	Threshold adjustment ("tuning")	1 Turn	
	Discriminator	1 Turn	
	Sensitivity	1 Turn	
	Volume	1 Turn	
	Ground balance	Automatic	
	Sound	3 pos. switch	
	Search Coil	Type	Double-D
		Size (diameter)	203mm (8")
Weight		475g	
Interchangeable		Yes	
Audio Output	Cable length	2.3 m	
	Audio booster	Yes	
	Enhanced mode	Yes	
	Speaker	51mm (2 ") ,moisture resistant	
	Headphone Jack	1/4", stereo/mono	
Built-in Arm Rest & Detector Stand	Tone	Preset	
	Type	Yes	
	Shaft mount	Yes	
	Hip mount	Yes	
Batteries	Strap mount	Yes	
	Type	AA penlight cells	
	Number	8	
	Life-Alkaline	25-30 Hrs approx.	
Warranty	Life - Rechargeable NiCads	5-8 Hrs approx.	
	Battery low alert	Automatic	
	Control Box	2 Years parts and labour, limited	
	Search Coil	1 Year parts and labour, limited.	
Patents	US4894618, AUS595835, CAN1260146		
	US4890064, others pending		